

# CAD 2D

**Ingeniería Gráfica**

*Curso 2010-2011*

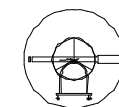

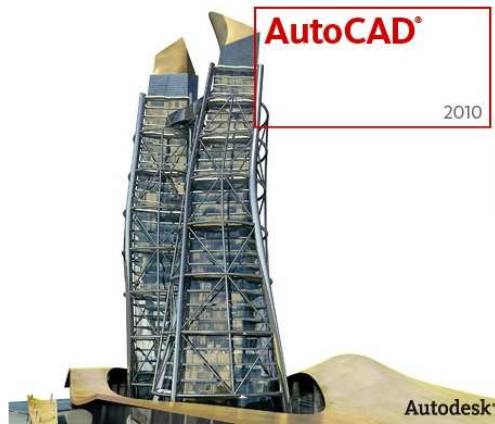

# Dibujo Entidades 2D

(continuación)

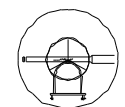

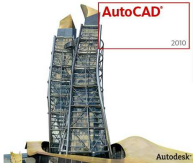

# Dibujo de entidades 2D

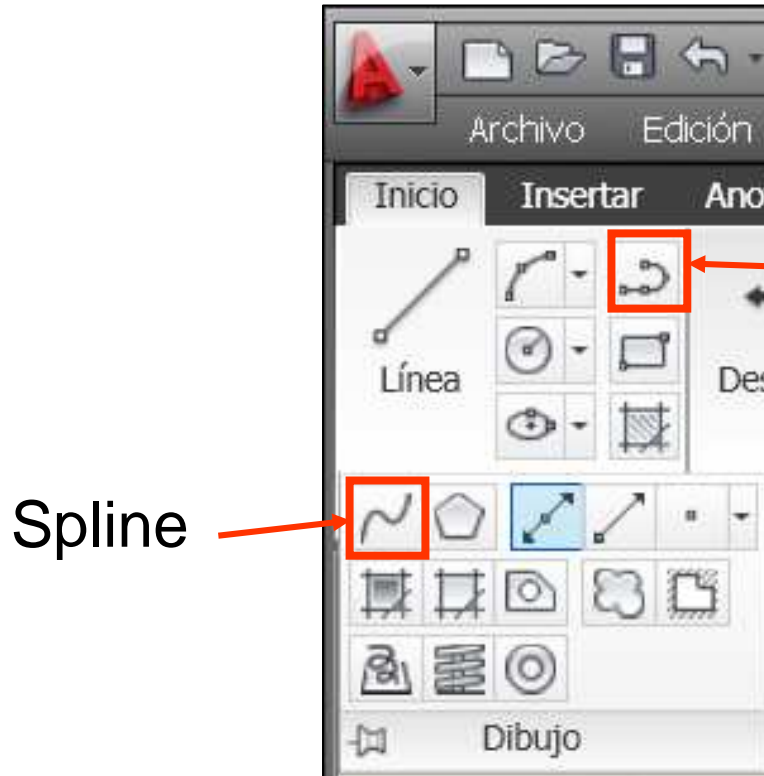

Polilínea

Spline

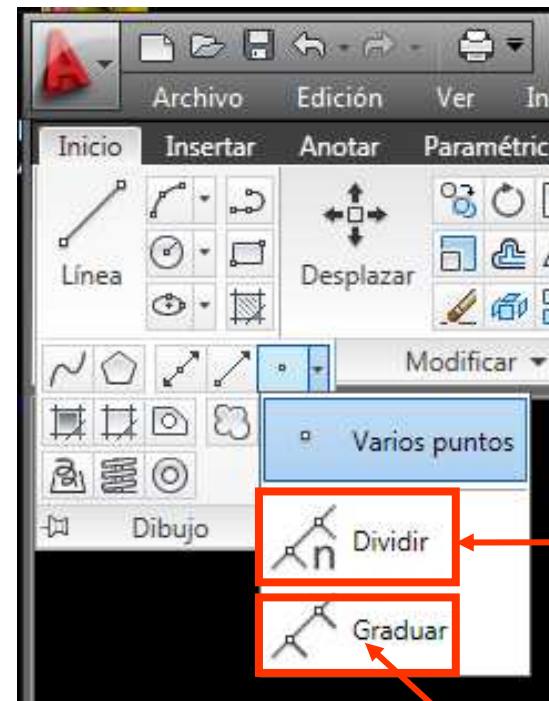

Dividir

Graduar

# Dibujo de entidades 2D

## Sombreado

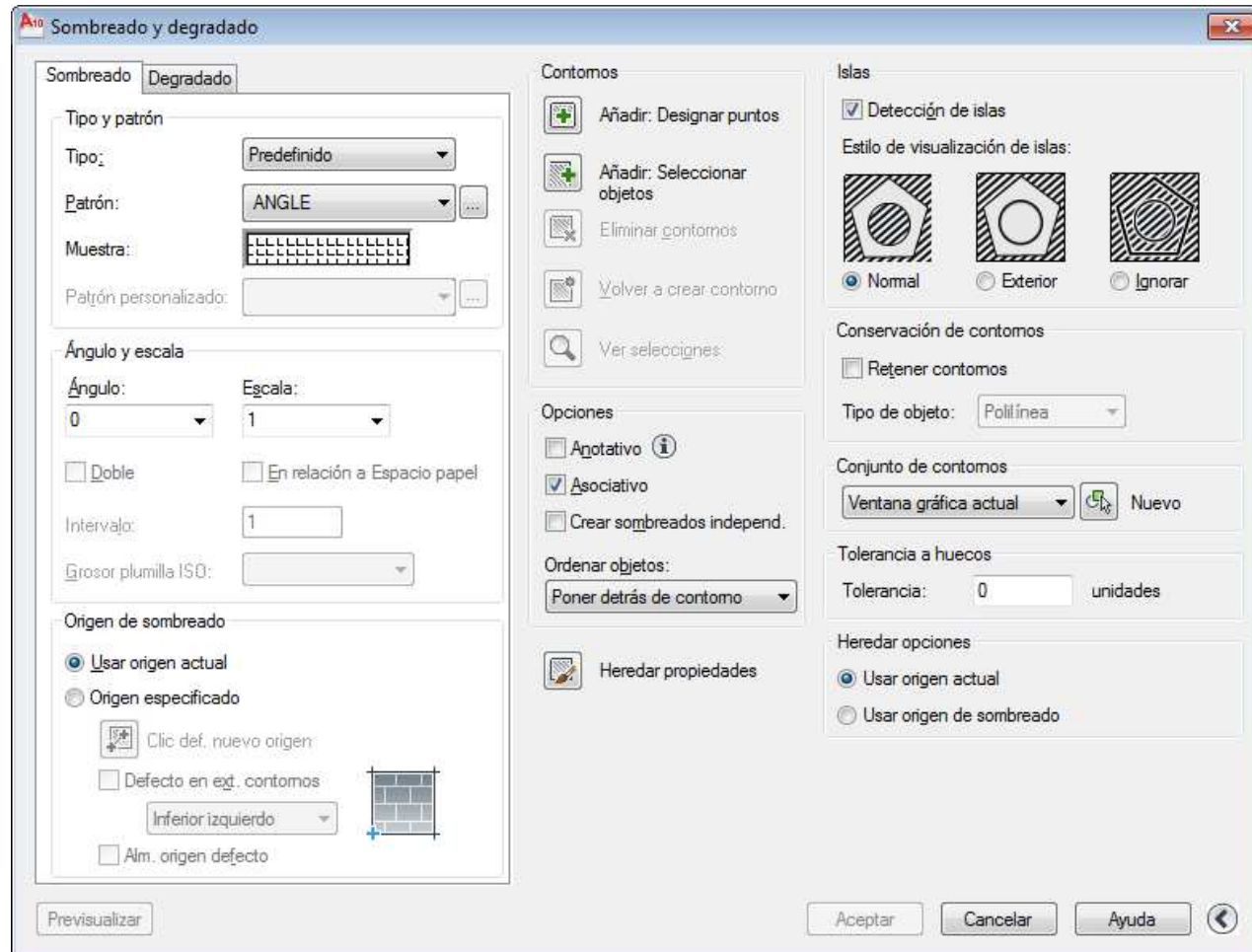
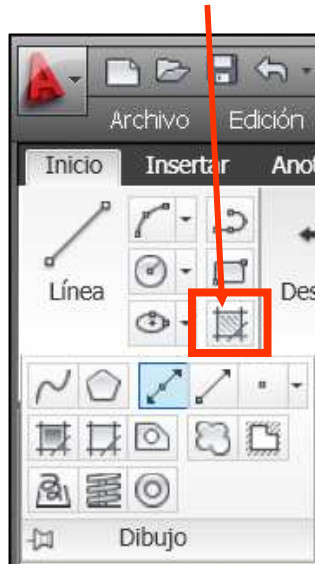

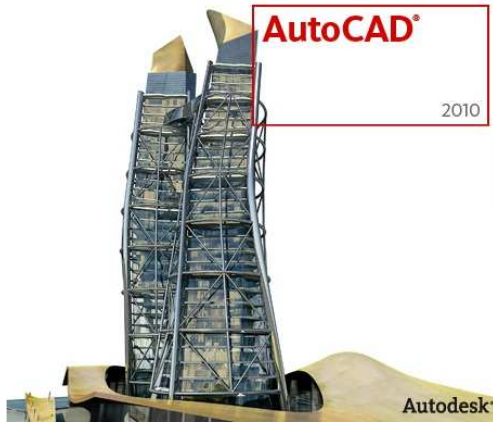

# Modificación Entidades 2D

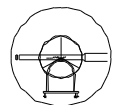

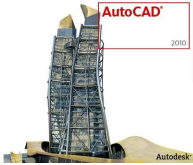

# Modificación entidades 2D

Mover Copiar Simetría

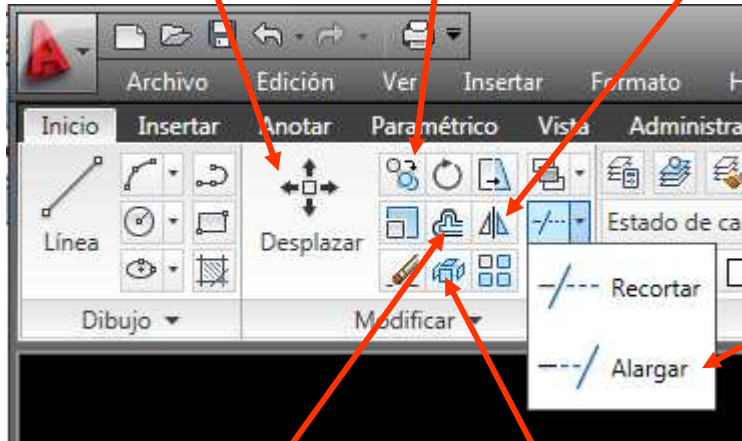

Alargar

Girar

Empalme

Equidistancia Descomponer

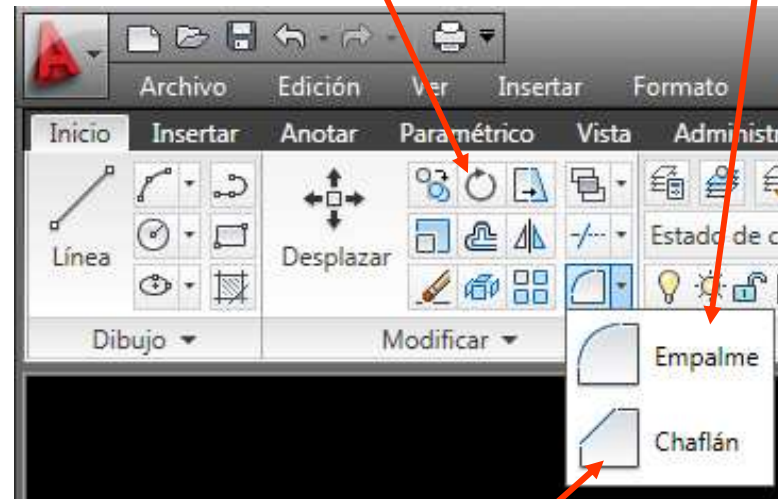

Chablán



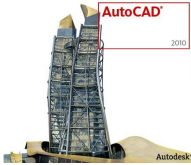

# Modificación entidades 2D

Girar

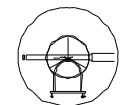
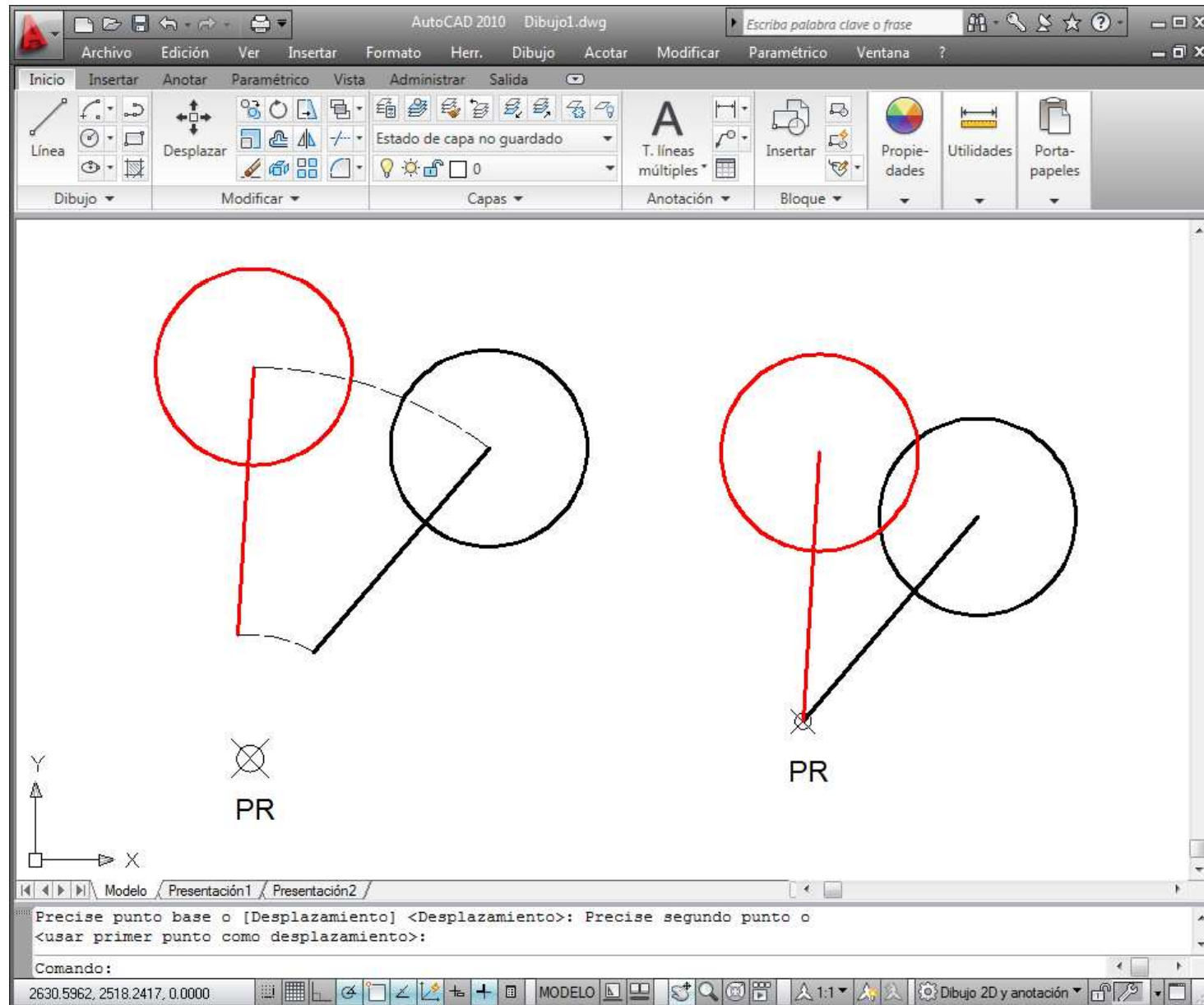

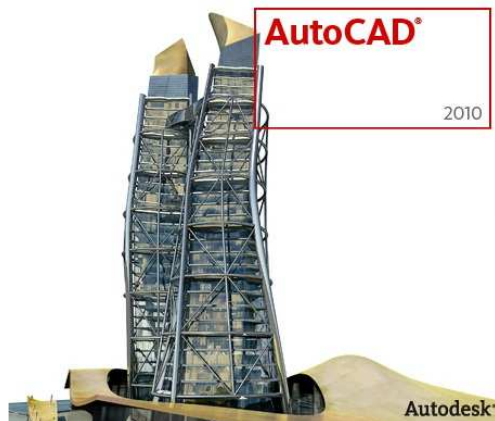

# Ayudas al diseño

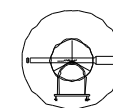



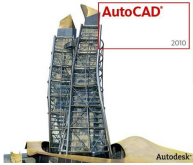

# Ayudas al diseño

- Rastreo Polar
- Rastreo de referencia a objetos (*AutoTrack*)

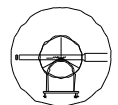

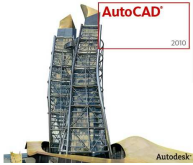

# Ayudas al diseño

- Rastreo Polar
- Rastreo de referencia a objetos (*AutoTrack*)

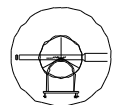

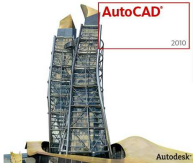

# Rastreo Polar (Ayudas al diseño)

- El rastreo polar restringe el movimiento del cursor a ángulos precisados.
- Parametrizable

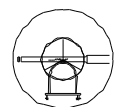
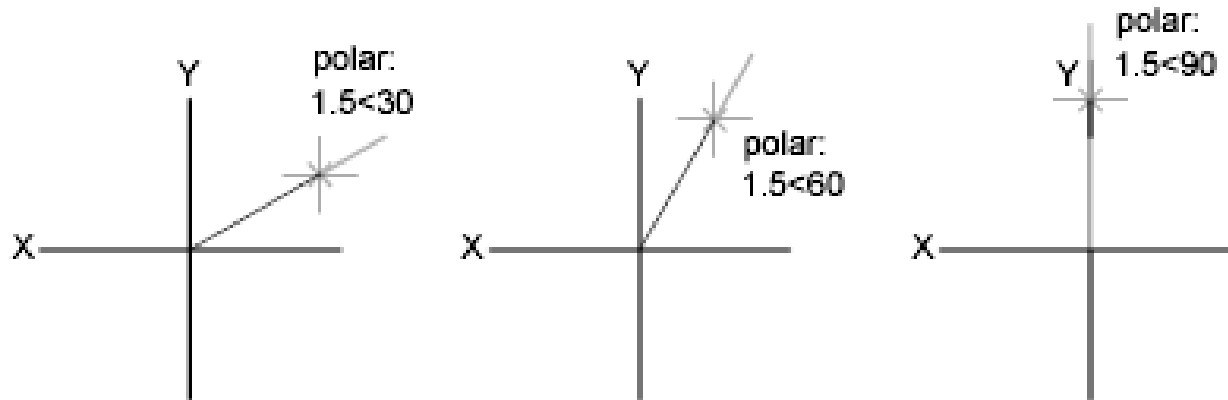

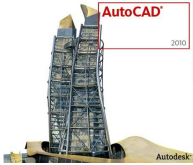

# Rastreo Polar (Ayudas al diseño)

- Botón derecho ratón sobre icono
- Modificar **Parámetros...**

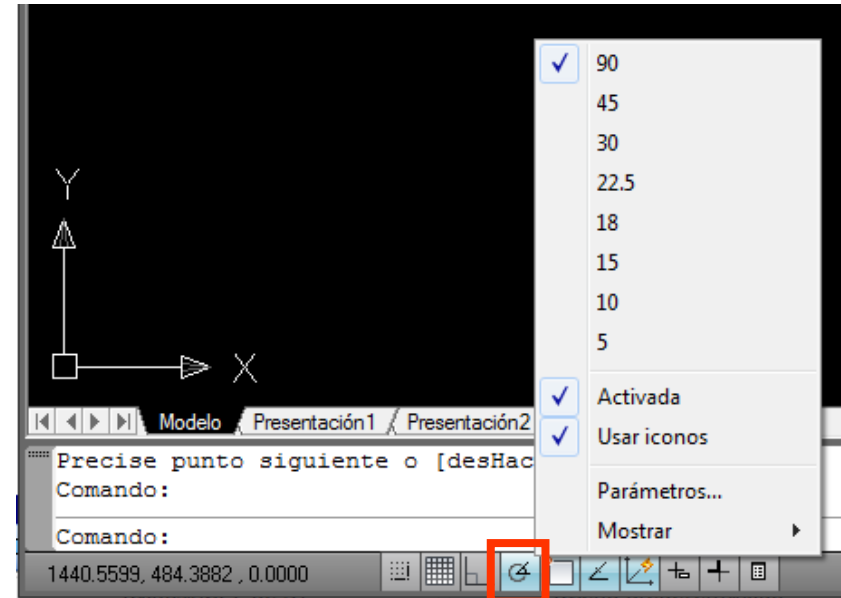
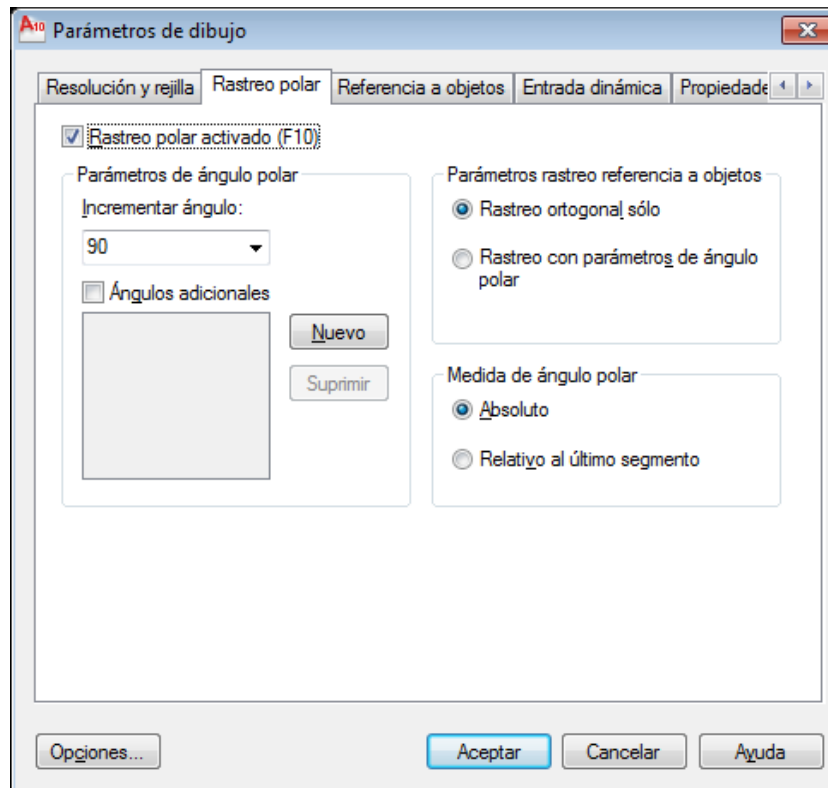

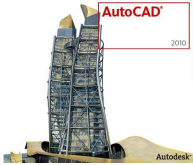

# Ayudas al diseño

- Rastreo Polar
- **Rastreo de referencia a objetos (*AutoTrack*)**

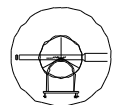

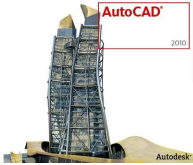

# Rastreo Ref objetos (Ayudas al diseño)

- Permite dibujar objetos en ángulos determinados o en relación con otros objetos situados a lo largo de las direcciones conocidas como rutas de alineación.

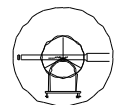
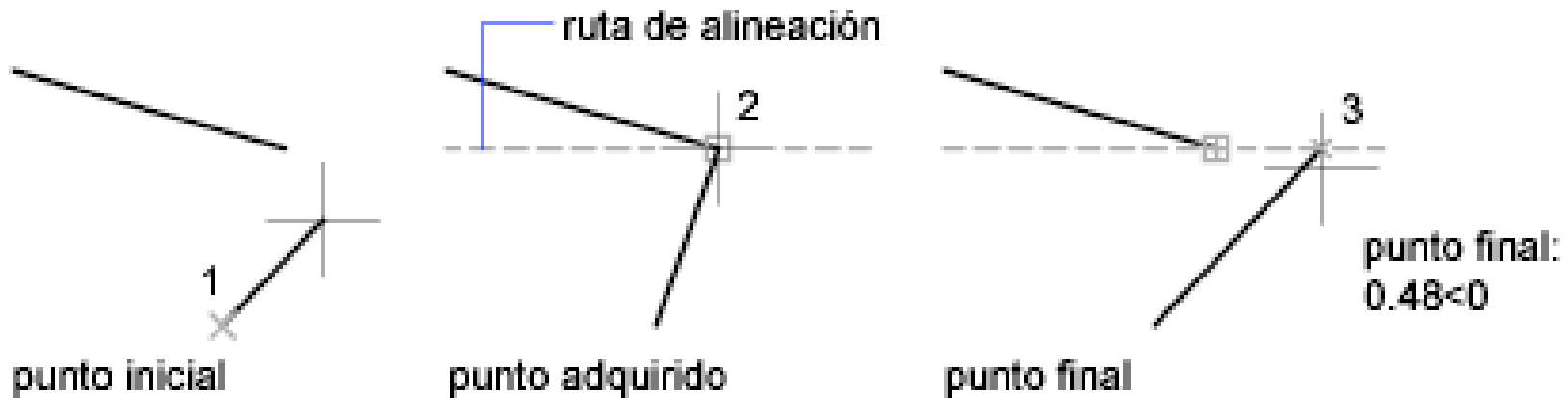

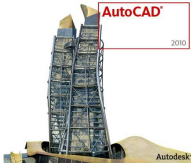

# Rastreo Ref objetos (Ayudas al diseño)

- Botón derecho ratón sobre icono
- Modificar **Parámetros...**

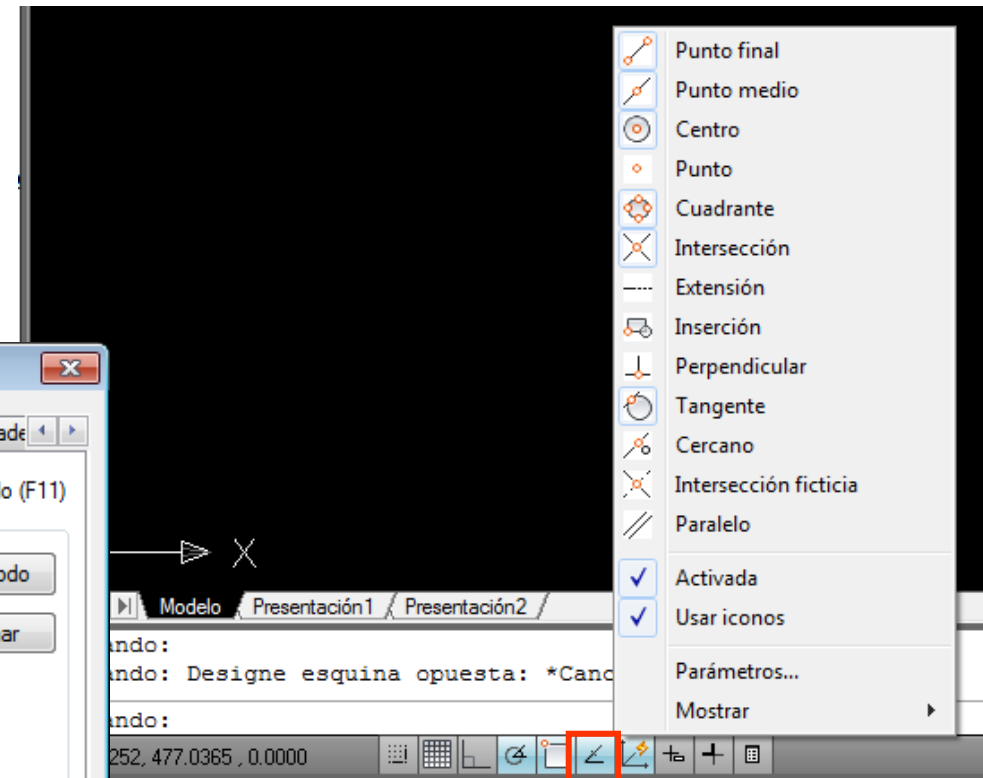
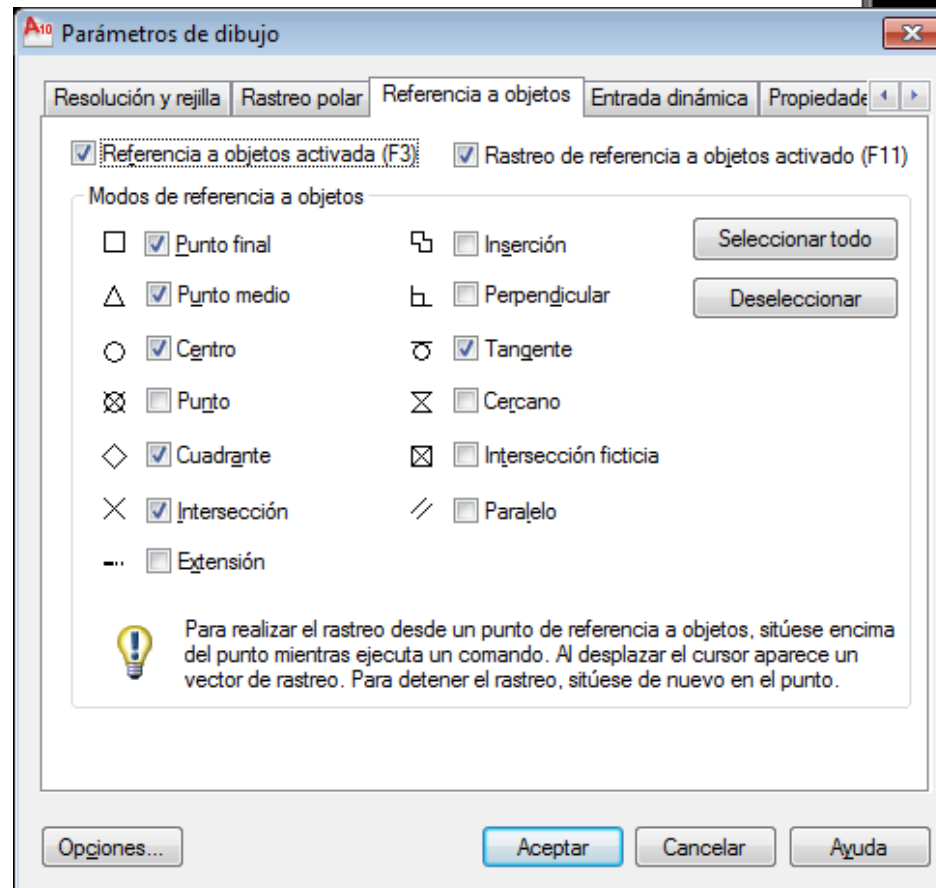



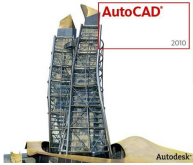

# Rastreo Ref objetos (Ayudas al diseño)

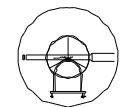
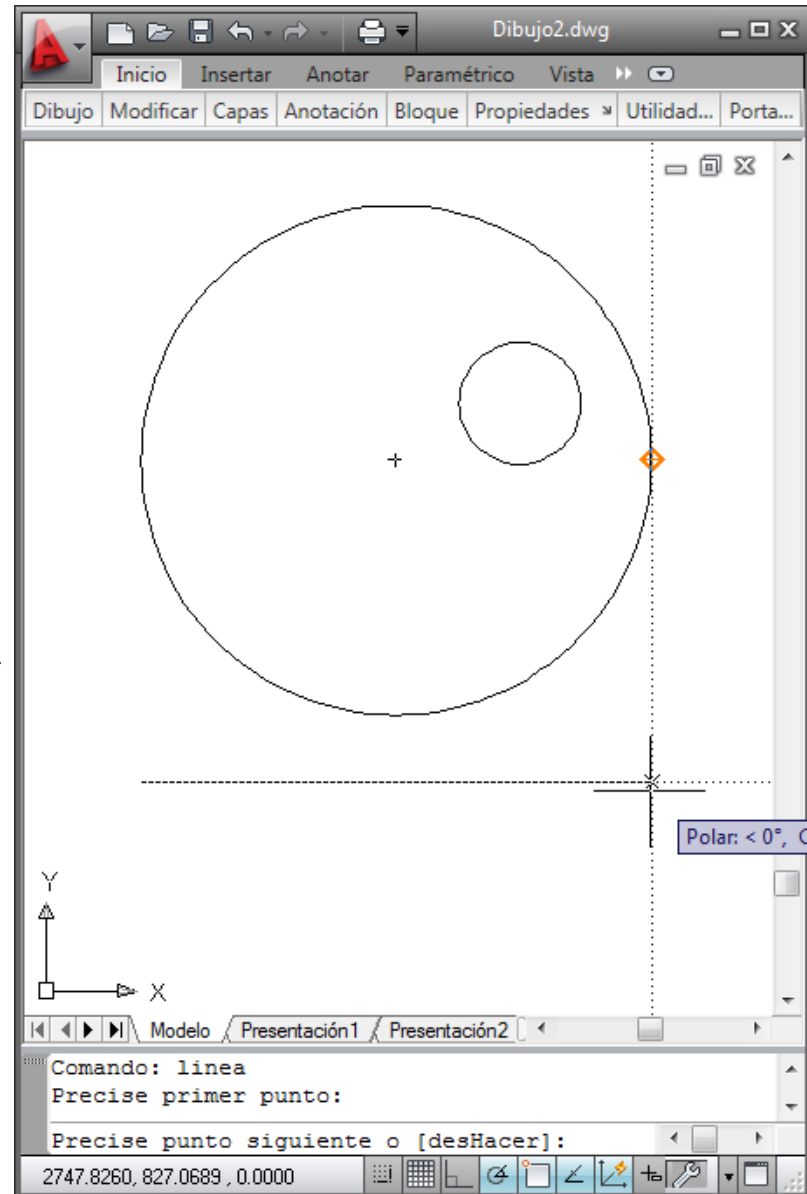
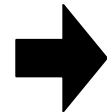
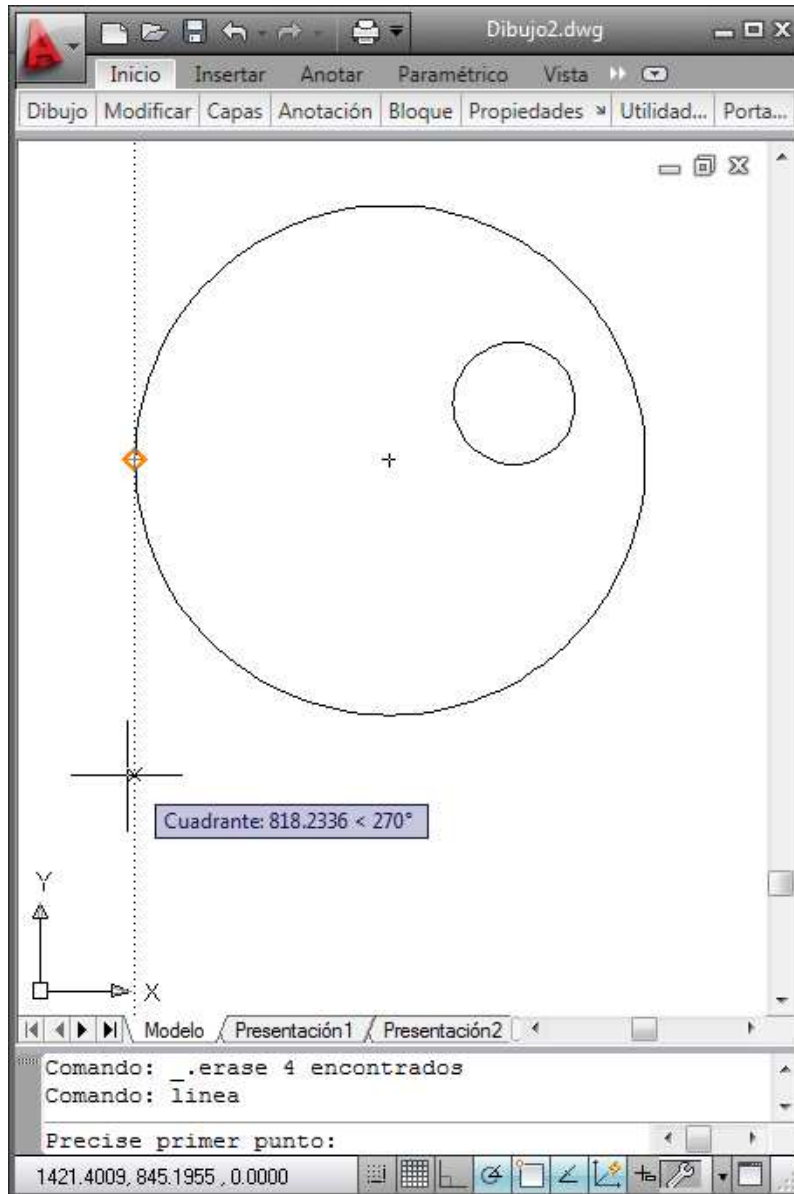

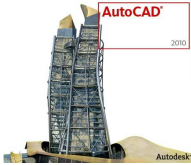

# Rastreo Ref objetos (Ayudas al diseño)

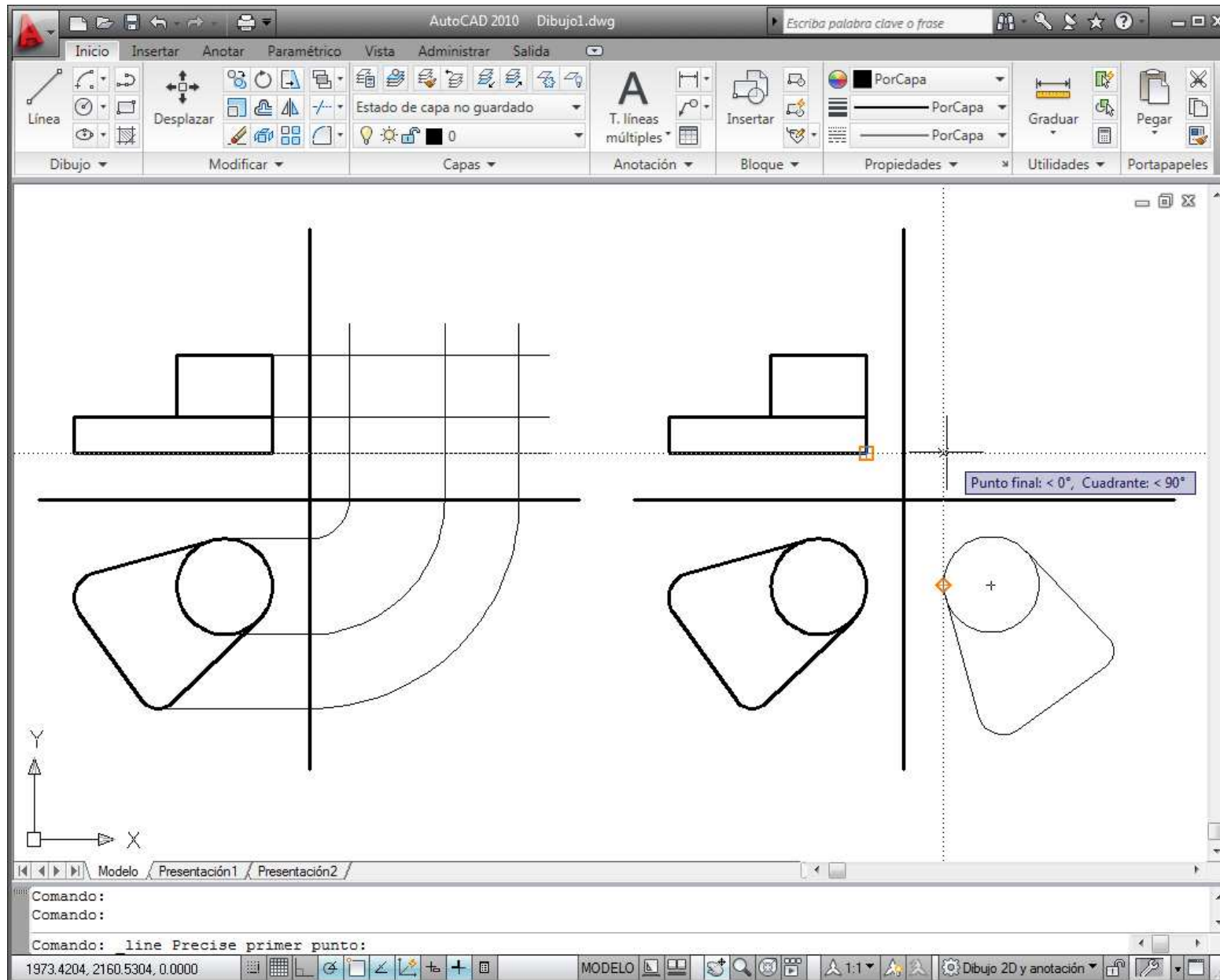

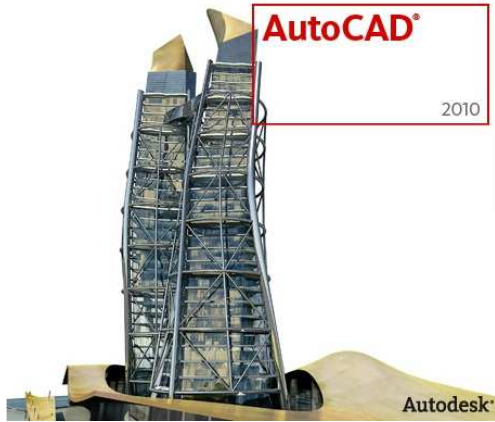

# A dibujar...

