

CAD 2D

Técnicas de Representación Gráfica

Curso 2010-2011

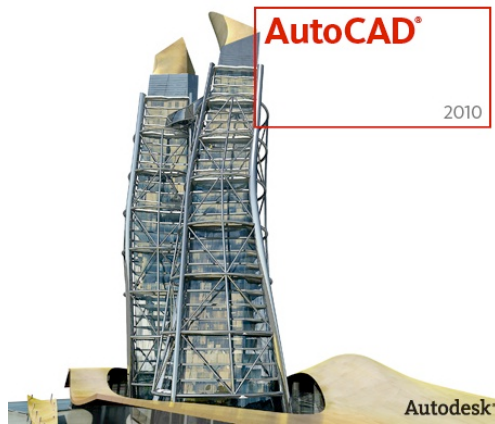



Dibujo Entidades 2D

(continuación)



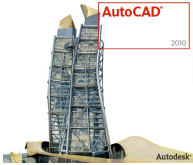

Dibujo de entidades 2D

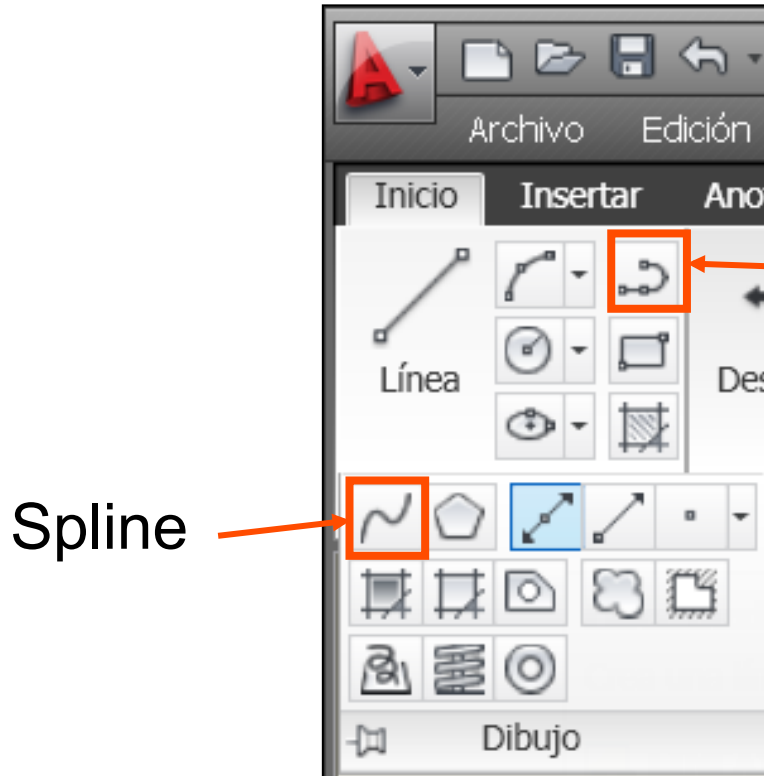

Polilínea

Spline

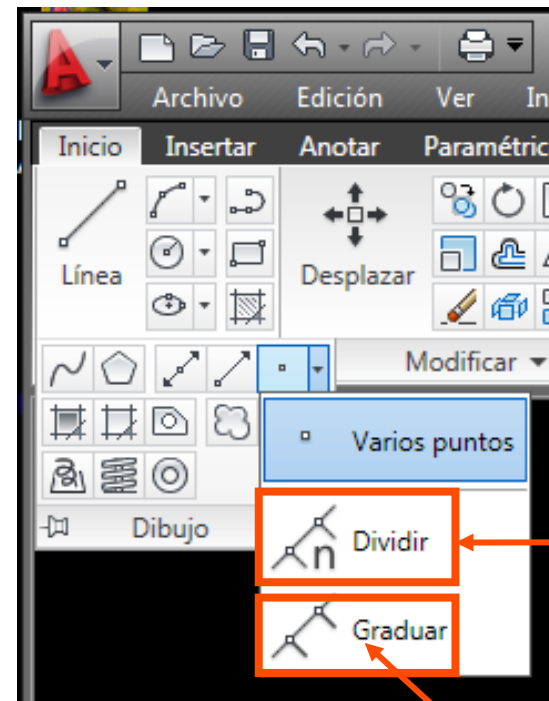

Dividir

Graduar



Dibujo de entidades 2D

Sombreado

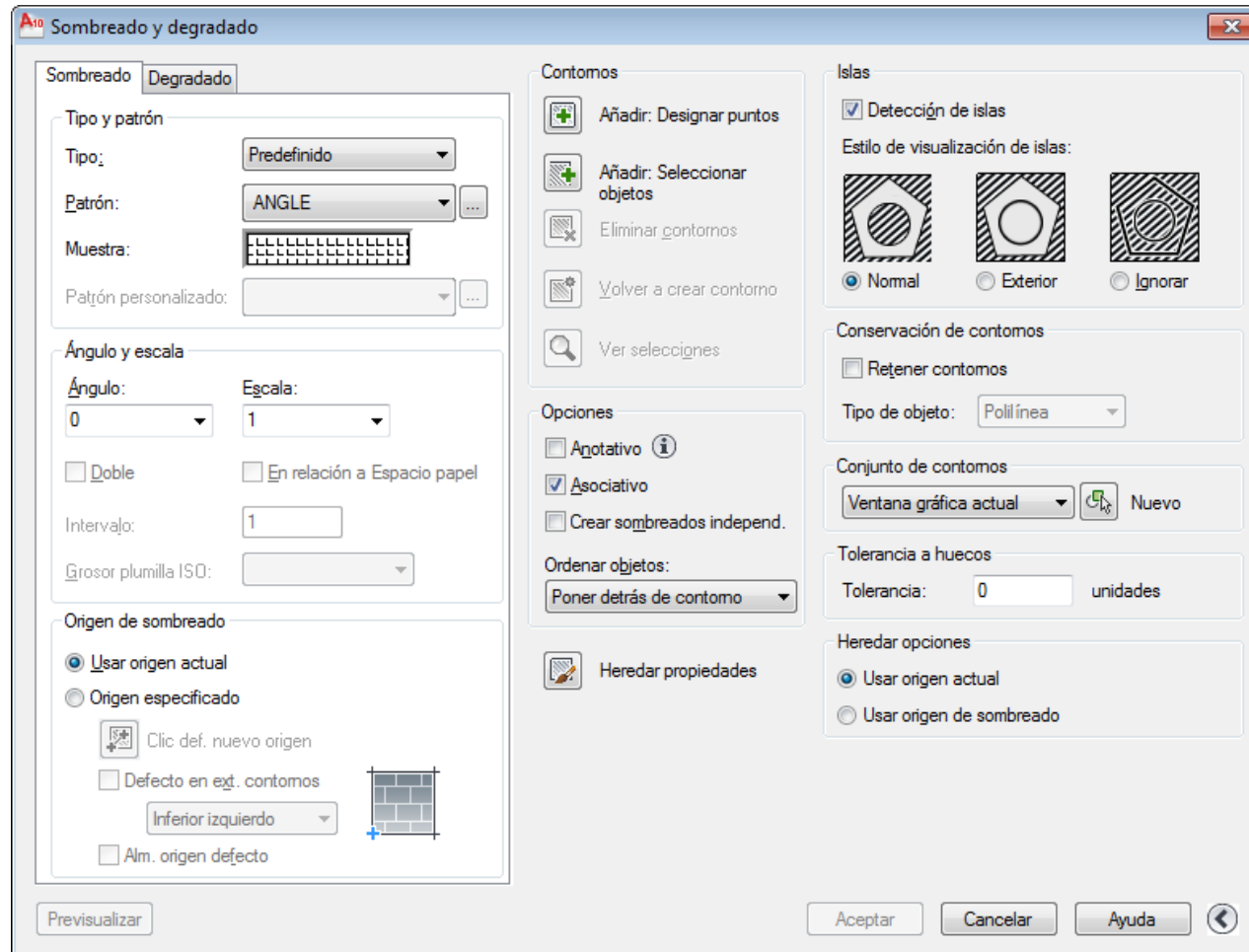
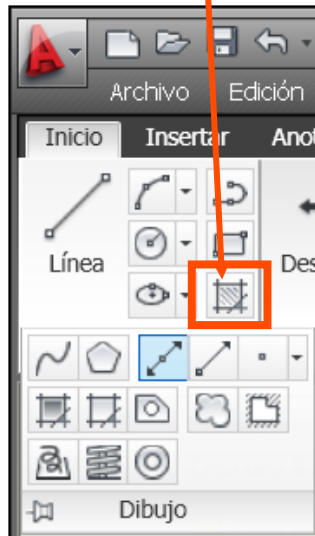

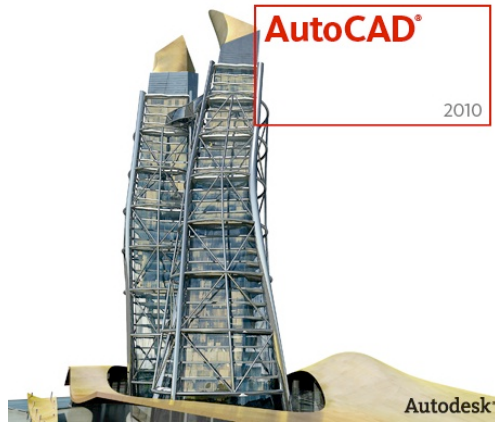

Modificación Entidades 2D



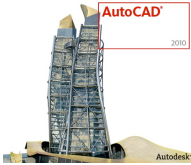

Modificación entidades 2D

Mover Copiar Simetría

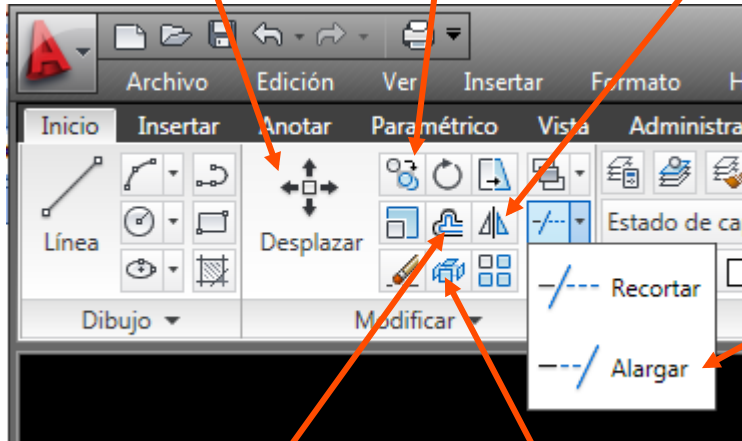

Alargar

Girar

Empalme

Equidistancia Descomponer

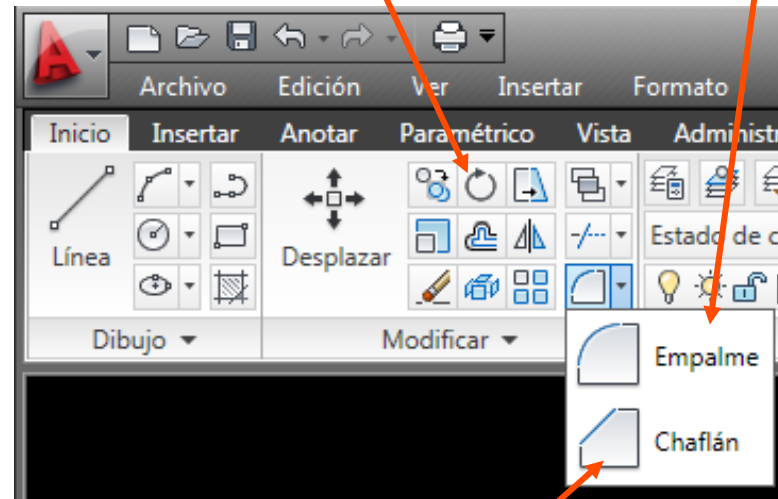

Chaflán



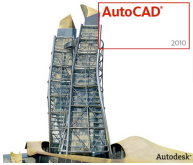

Modificación entidades 2D

Girar

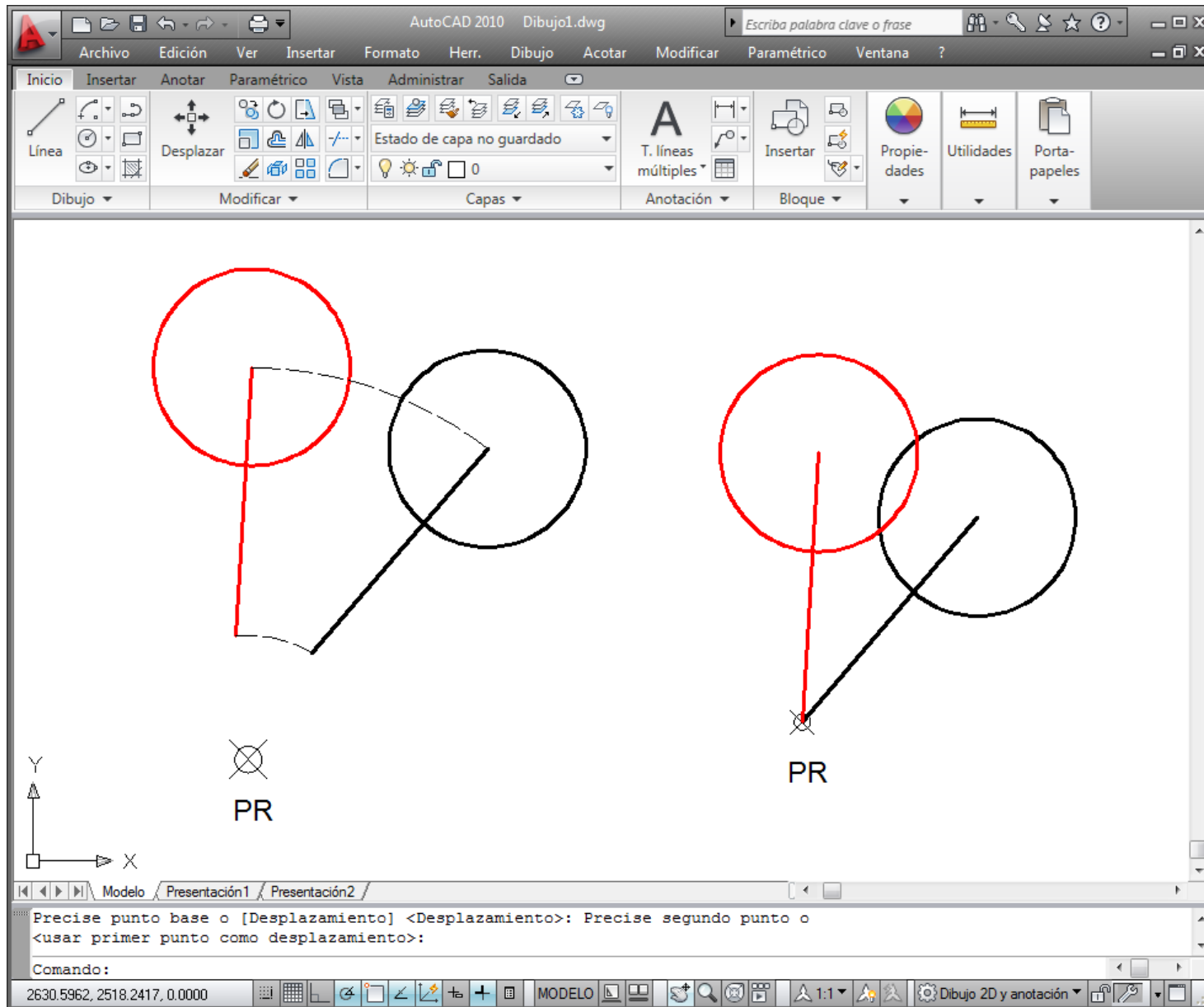

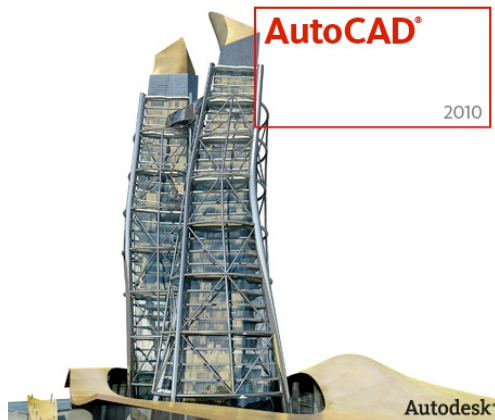

Ayudas al diseño



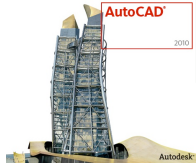

Ayudas al diseño

- Rastreo Polar
- Rastreo de referencia a objetos (*AutoTrack*)



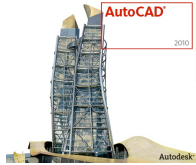

Ayudas al diseño

- Rastreo Polar
- Rastreo de referencia a objetos (*AutoTrack*)



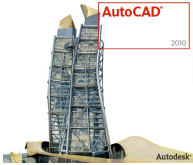

Rastreo Polar (Ayudas al diseño)

- El rastreo polar restringe el movimiento del cursor a ángulos precisados.
- Parametrizable

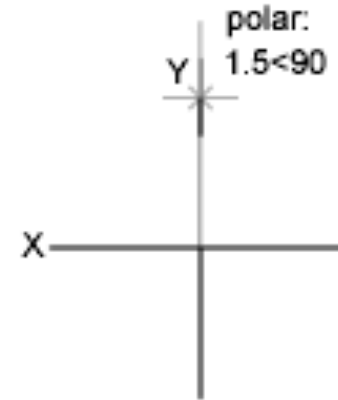
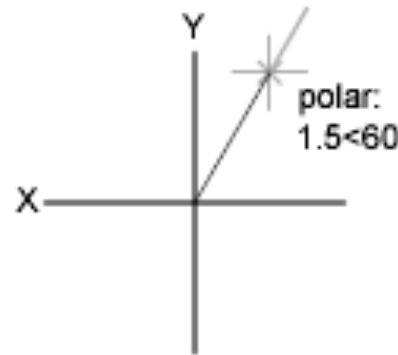
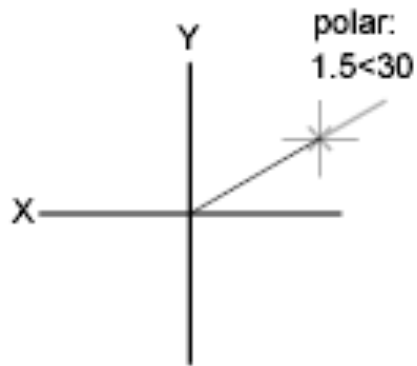

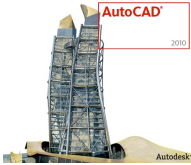

Rastreo Polar (Ayudas al diseño)

- Botón derecho ratón sobre icono
- Modificar **Parámetros...**

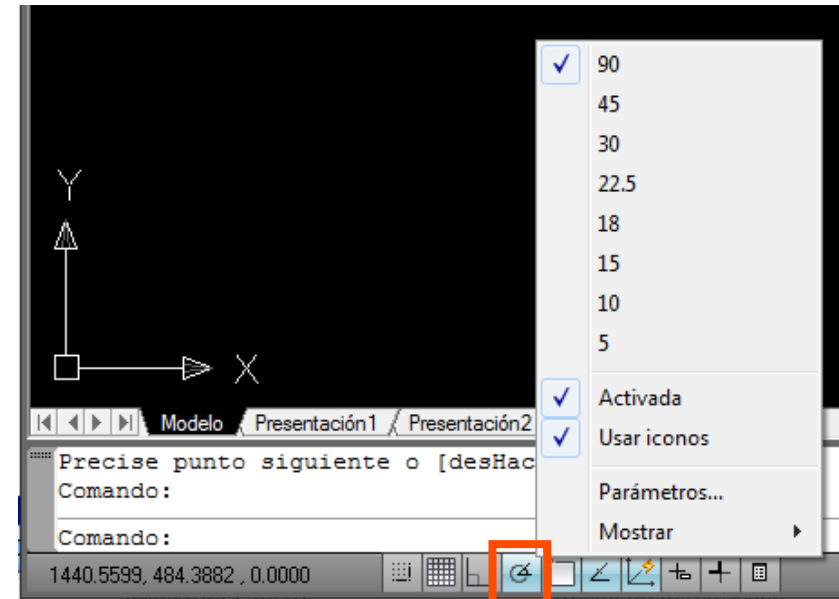
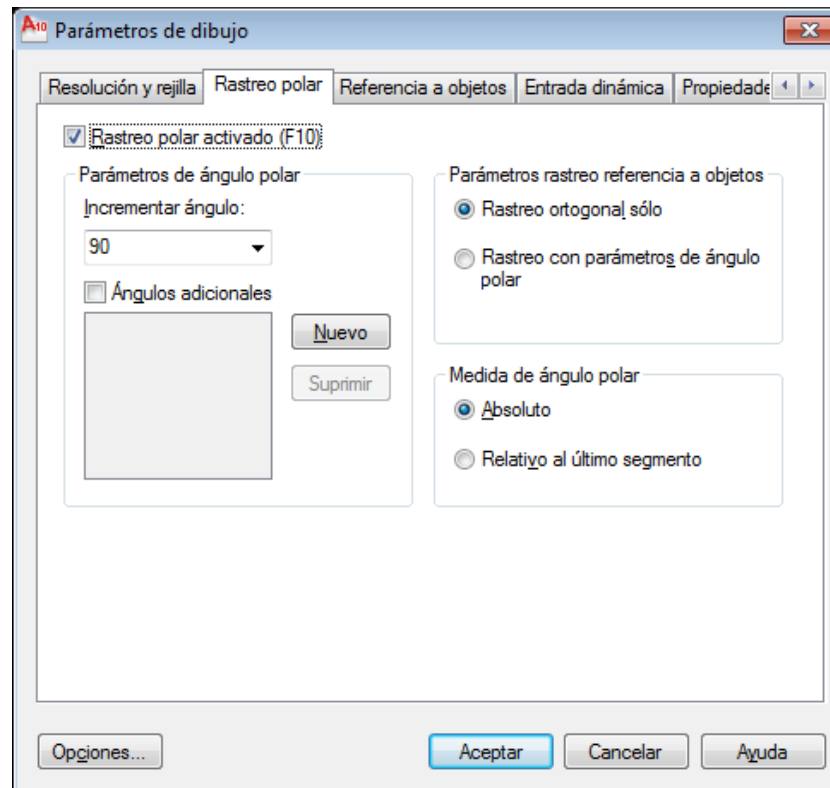

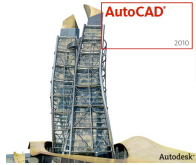

Ayudas al diseño

- Rastreo Polar
- **Rastreo de referencia a objetos (*AutoTrack*)**



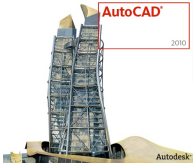

Rastreo Ref objetos (Ayudas al diseño)

- Permite dibujar objetos en ángulos determinados o en relación con otros objetos situados a lo largo de las direcciones conocidas como rutas de alineación.

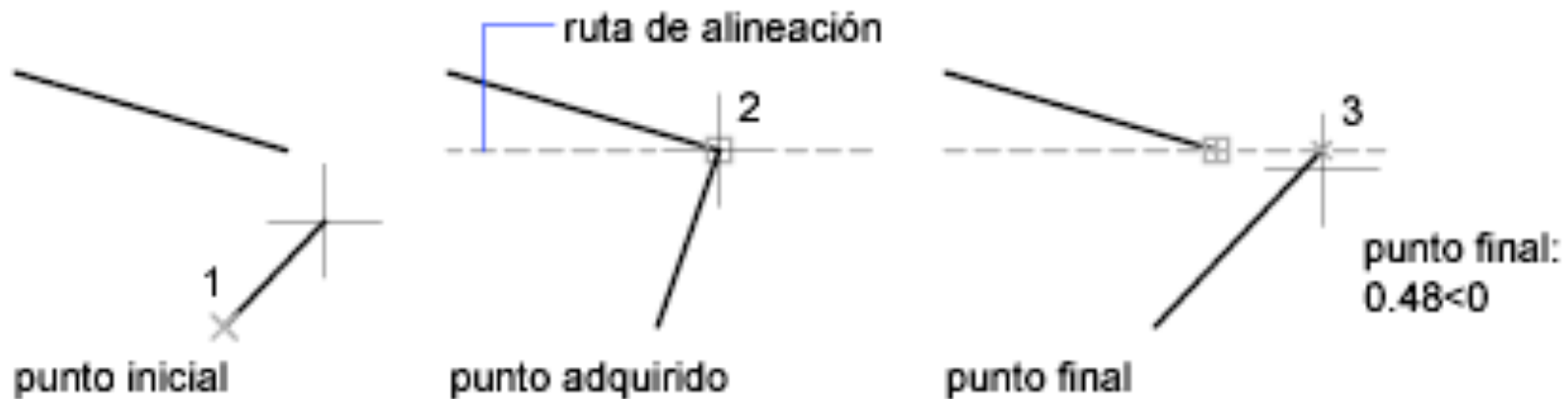

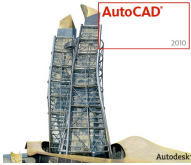

Rastreo Ref objetos (Ayudas al diseño)

- Botón derecho ratón sobre icono
- Modificar **Parámetros...**

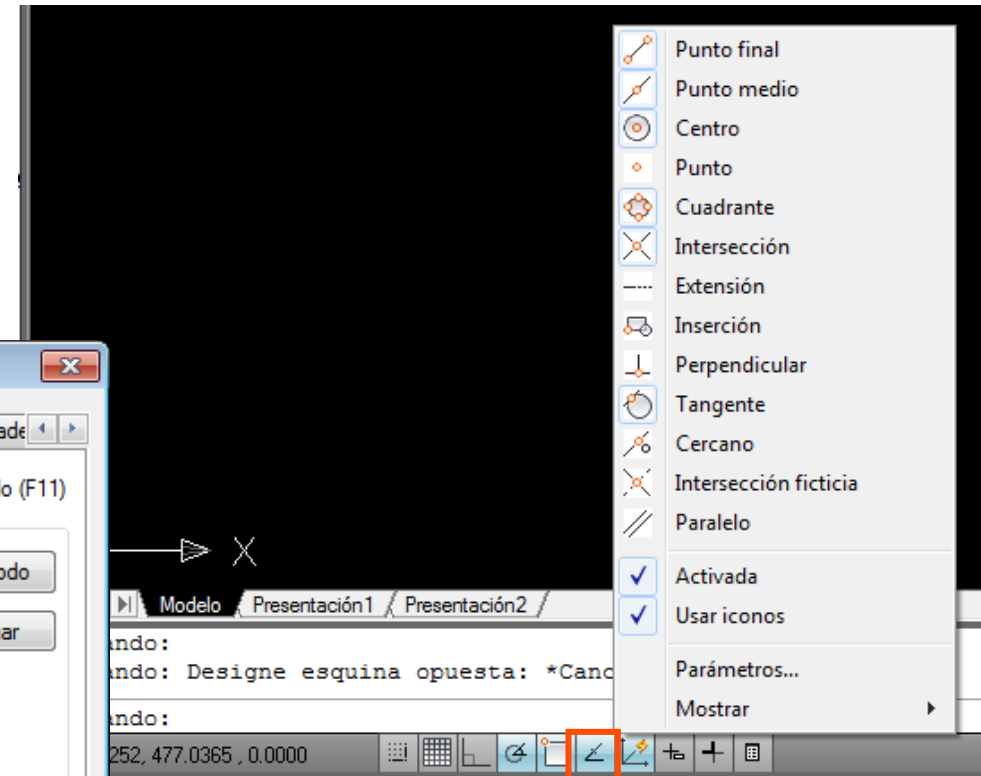
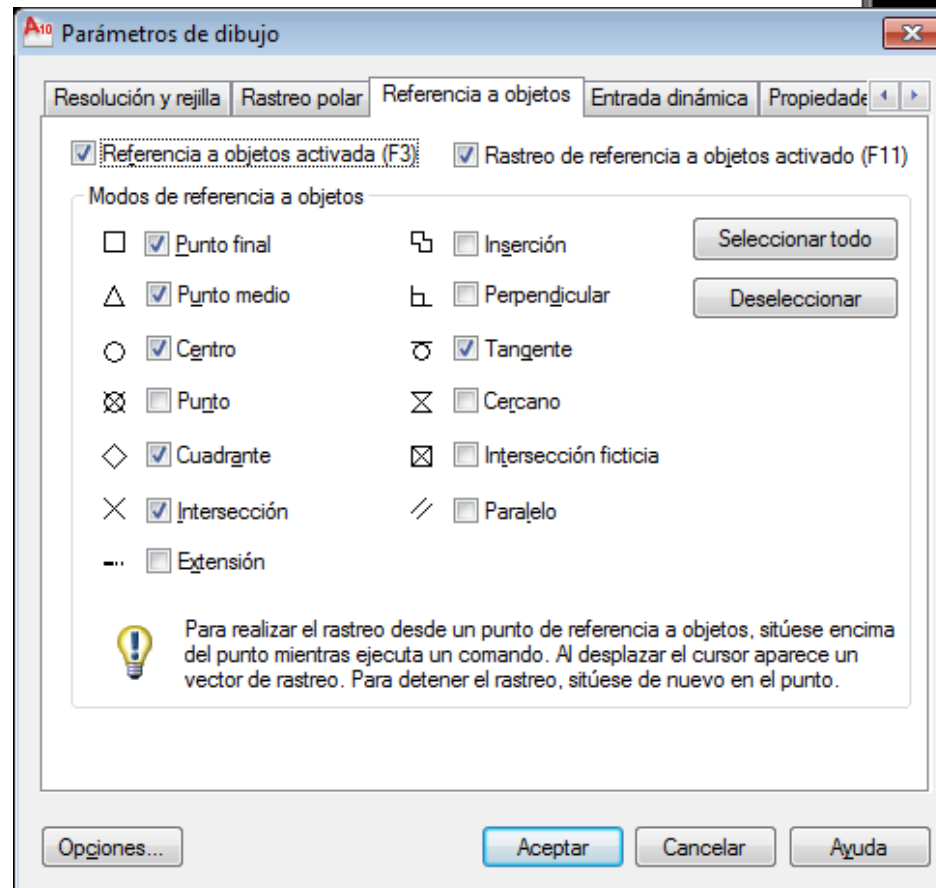

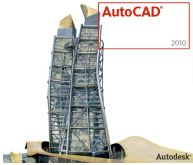

Rastreo Ref objetos (Ayudas al diseño)

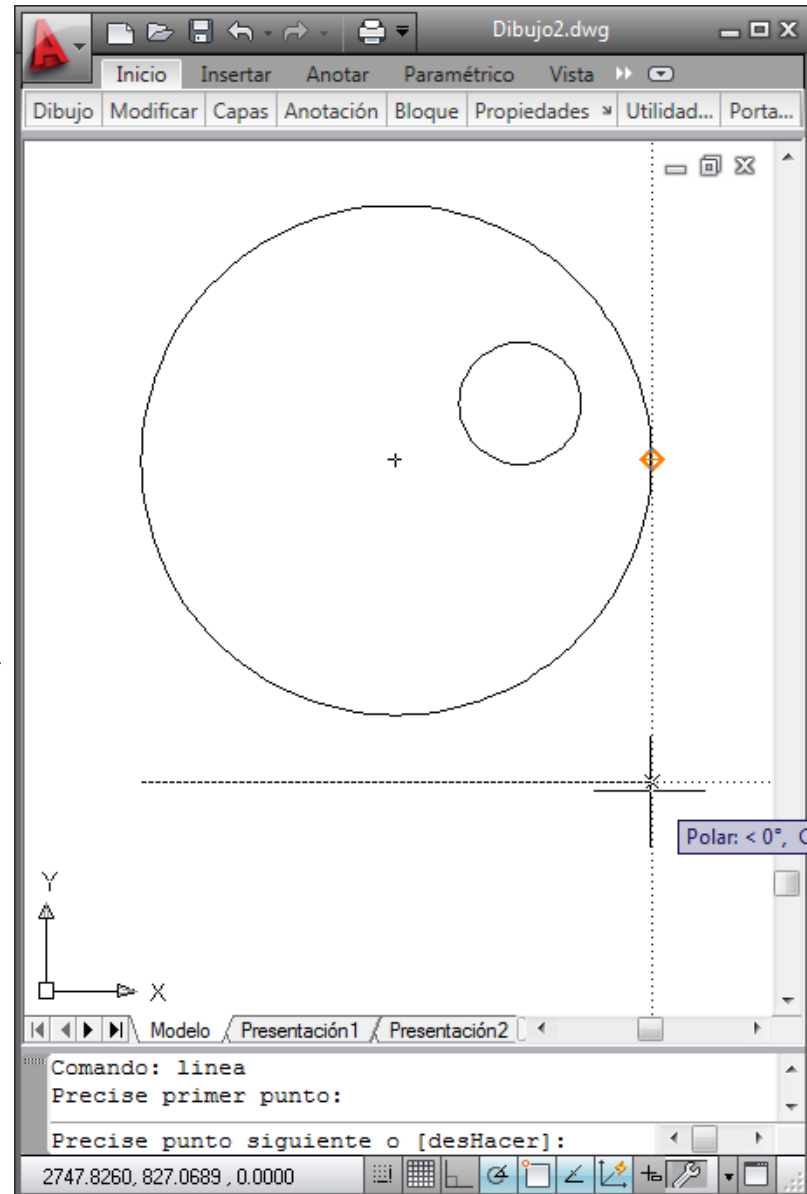
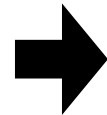
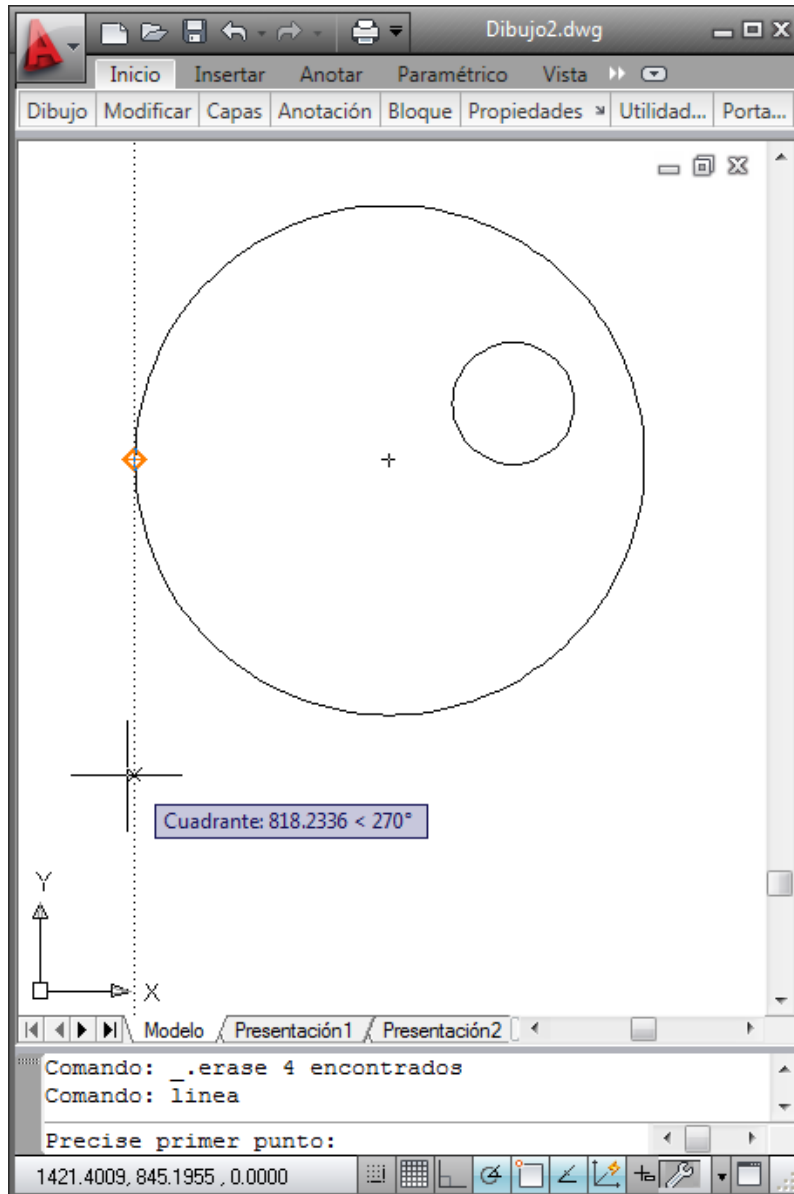

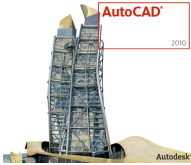

Rastreo Ref objetos (Ayudas al diseño)

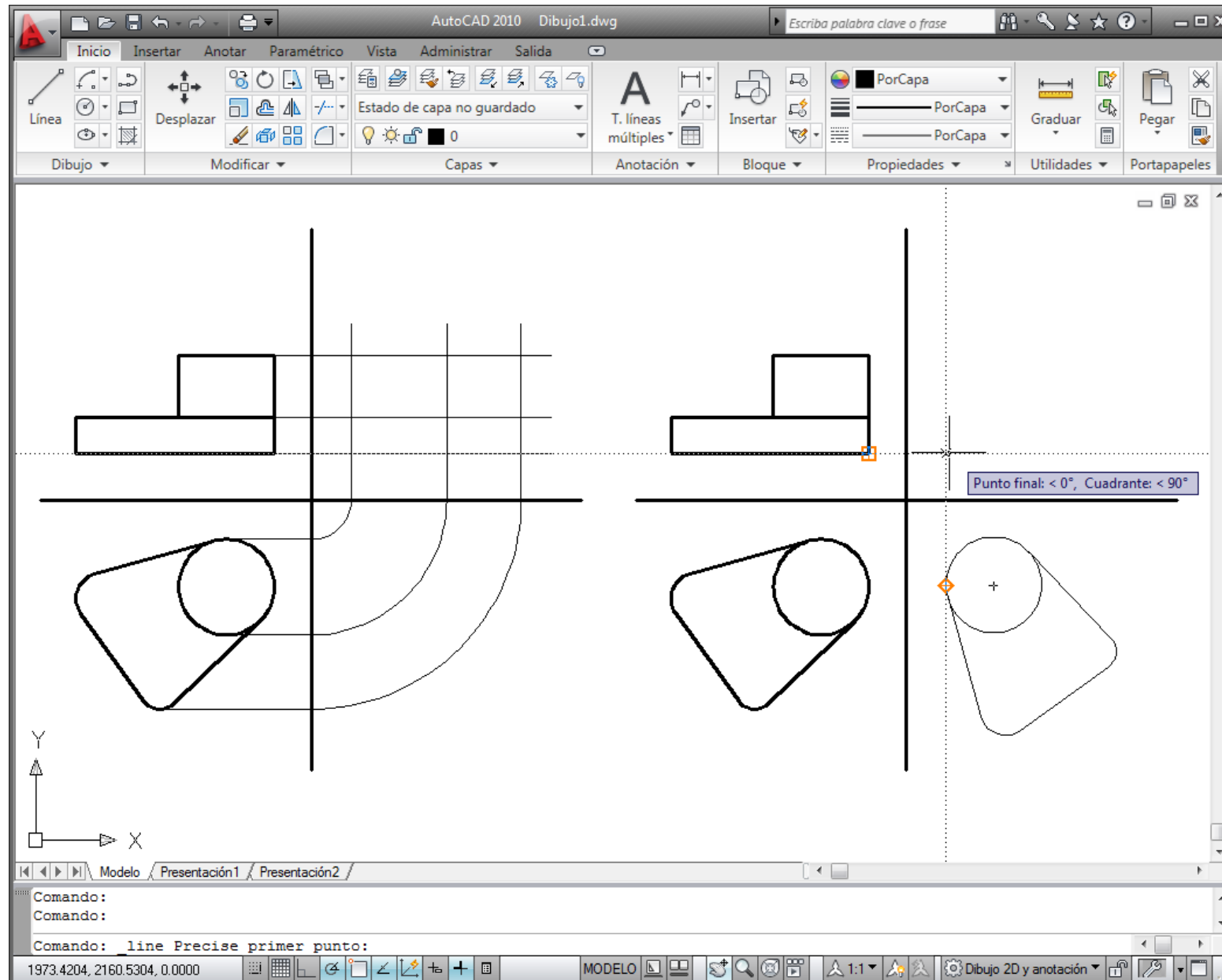

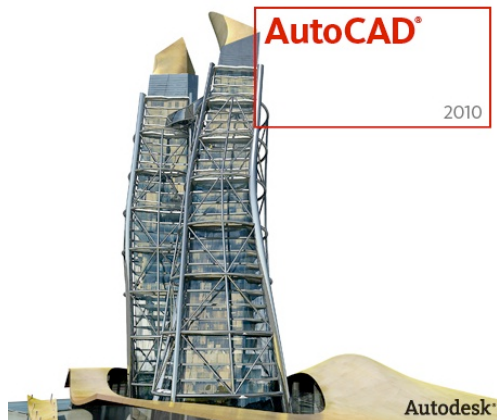

A dibujar...

